

Special Right Triangles Worksheet # 2 Name: _____

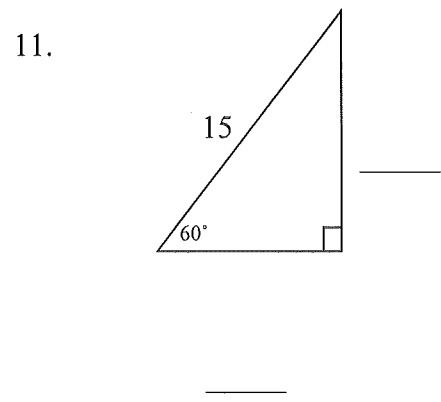

12. Equilateral Triangle

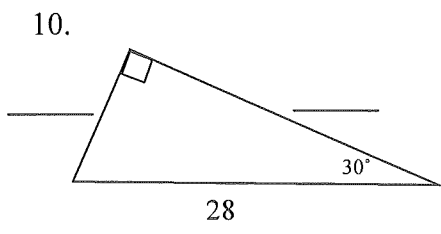
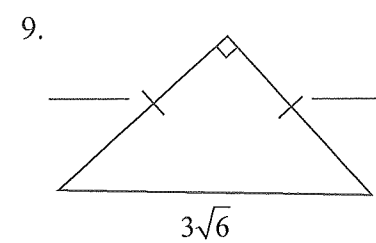
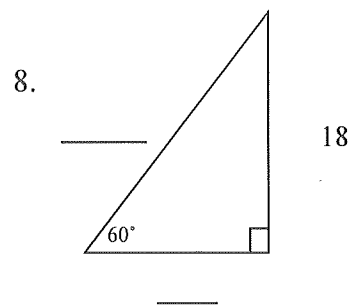
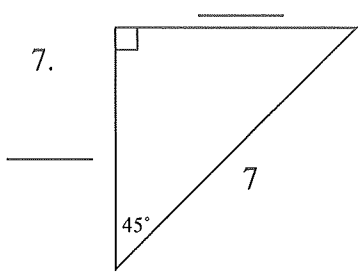
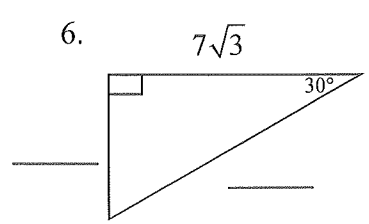
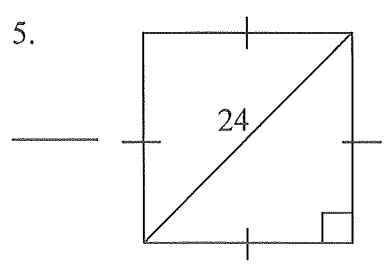
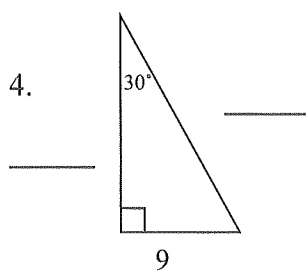
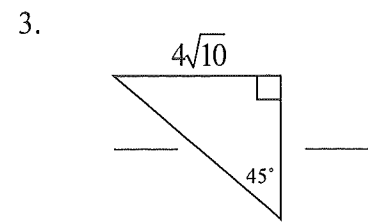
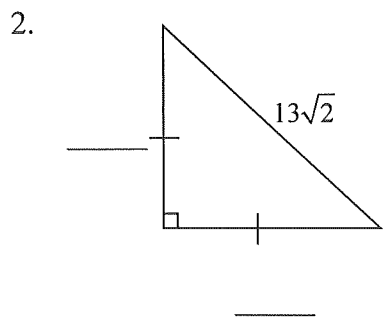
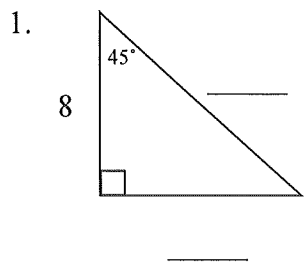